



## PERFORMANCE EVALUATION OF OFDM SYSTEM USING CONVOLUTION CODE UNDER AWGN, RAYLEIGH AND Rician CHANNEL

\*Abdulbagi Elsanousi and Sıtkı Öztürk

Electronic and Communication Engineering, Kocaeli University, Kocaeli, Turkey

### ARTICLE INFO

#### Article History:

Received 26<sup>th</sup> September, 2017  
Received in revised form  
19<sup>th</sup> October, 2017  
Accepted 03<sup>rd</sup> November, 2017  
Published online 29<sup>th</sup> December, 2017

#### Key Words:

BER, OFDM,  
convolution code,  
Rician,  
AWGN,  
Rayleigh.

### ABSTRACT

Fourth-generation wireless communication system focus on two techniques which are, MIMO (Multiple Input and Multiple Output) and OFDM (Orthogonal Frequency Division Multiplexing) this paper demonstrates performance of BER of OFDM system using convolution code which used to encrypt the data stream that can be sent over communication channels, for different digital modulation schemes (8QAM, 16QAM, 32QAM and 64QAM) simulations in Matlab has been done for three different channels (AWGN, Rician and Rayleigh), The obtained results show that 8QAM has good performance compared to other digital modulation schemes.

Copyright ©2017, Abdulbagi Elsanousi and Sıtkı Öztürk. This is an open access article distributed under the Creative Commons Attribution License, which permits unrestricted use, distribution, and reproduction in any medium, provided the original work is properly cited.

Citation: Abdulbagi Elsanousi and Sıtkı Öztürk, 2017. "Performance Evaluation of OFDM System Using Convolution Code under AWGN, Rayleigh and Rician channel", *International Journal of Development Research*, 7, (12), 17585-17590.

## INTRODUCTION

Today data rate becomes high as Tele technology evaluate, in GSM data rate is only 9.6 Kbps in UMTS the data rate increases to 21 Mbps, Today in LTE network it can be more than 100 Mbps. OFDM involves Frequency Division Multiplexing and Multicarrier Communication. FDM divide the available band width in many subcarriers and allows multiple users to access system simultaneously. Different user's data transmit some different subcarrier between subcarriers there are guard band to avoid interference, in Multicarrier FDM the data of the users can be split into multiple Subcarriers and transmit them in parallel to make data rate higher. well OFDM the subcarriers are designed to be orthogonal this allow subcarriers to overlap and save the bandwidth that achieving high data rate, therefor OFDM technology is adopted in LTE to make data rate higher. Due to of high bandwidth efficiency Orthogonal frequency division multiplexing (OFDM) system consider one of the best communication techniques.

Fourth-generation and fifth-generation uses OFDM which has ability to provide high spectral efficiency high data rate transmissions. As well as the various IEEE WLAN standards (802.11a, 802.11g, 802.11n and 802.11ac) are based on OFDM so it's key wireless technology which is used in several cellular because it's broadband wireless technology which enables high data rates at the same time it has practically and low complexity of a Implantation. In OFDM, high speed data streams of large bandwidth are split into parallel, slower substreams of lower bandwidth called sub carriers. These sub carriers are centered around frequencies in multiples of 15 KHz on both sides of D.C. As the lowest subcarrier is of 15KHz. Symbol duration, TS is equal to 1/15 KHz or 66.7 microseconds. Consequently a subcarrier can provide a symbol rate of 15 Kilo symbol per second. Which analogous to having a symbol rate of one Symbol/ Second/ Hertz of bandwidth or half the Nyquist rate.

### Principle of ofdm system

Dividing a high-rate data stream into fewer rate streams which are then transmitted at the same time in parallel over a number of subcarriers is the fundamental principle of OFDM.

\*Corresponding author: Abdulbagi Elsanousi,  
Electronic and Communication Engineering, Kocaeli University,  
Kocaeli, Turkey.

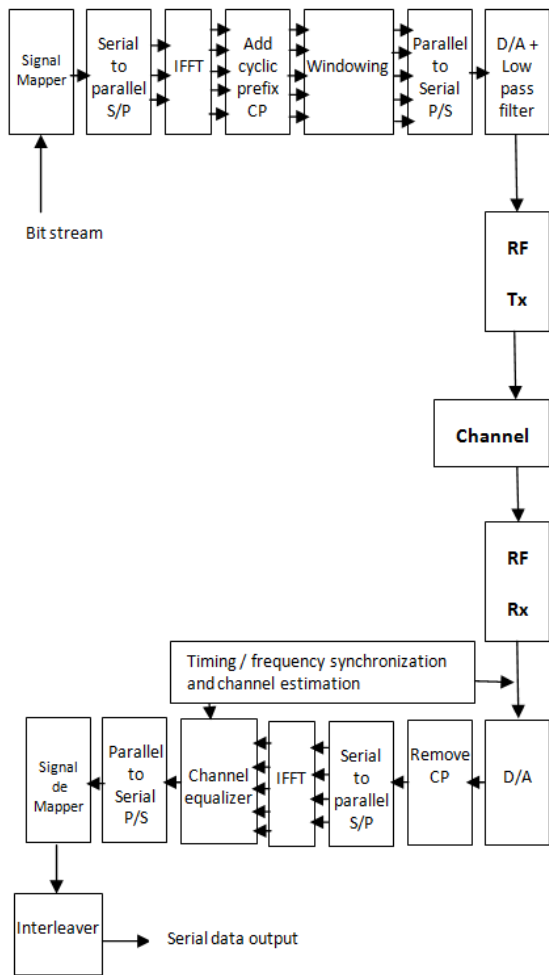

Figure 1. Block Diagram of OFDM System

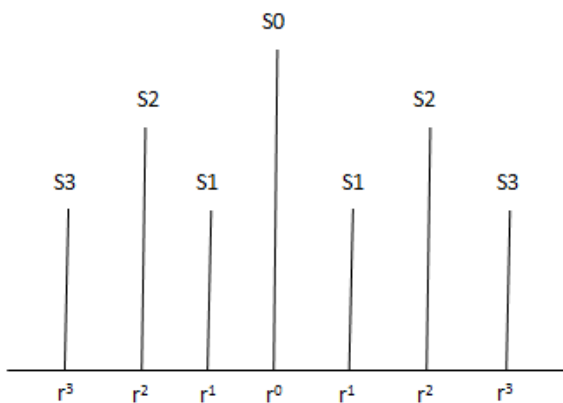

Figure 2. Frequency Domain Distribution of Symbols

The set-to-be-used and scheme of modulation the carrier power that are separately controlled per carrier allow for a high spectral efficiency in OFDM systems. OFDM is produced by selecting the required spectrum, which uses the input data (stream of bits) as a base, and modulation scheme that are set to be used. All the sub-carriers are cautiously controlled to allow the maintenance of the Orthogonality condition between the carriers. Each sub-carrier OFDM system is given the same data while being transmitted. A binary message that takes the form of bits at the transmitter is generated which has a length divisible by the number of sub-carriers as has Demonstrated in the below Figure (1). Each sub-carrier has its signal first modulated, and in OFDM system, they are able to adopt different modulation schemes like BPSK, QPSK, 8QAM, 16QAM, 64QAM, etc.

The channel conditions and the requirement of getting the highest form of balance between the Bit Error Rate (BER) and frequency spectrum utilization is what determine this. The input serial stream of data is then changed over to parallel arrangements of data at the transmitter. In OFDM systems, each data sets contain a symbol, say  $S_n$ , for all subcarriers. 4 sets of data would be  $[S_0, S_1, S_2, S_3]$  for example. The arrangement of such data in the horizontal axis in the frequency domain is shown in Fig2. The frequency distribution domain of symbols then takes the symmetrical arrangement about the vertical axis. This arrangement is important when it comes to using the Inverse FFT for the process of converting the frequency domain data sets into sample data of the correlating time domain representation.

In OFDM, the OFDM system makes good use of the IFFT and that's due to the fact that, the samples of a waveform gets generated with orthogonal frequency components. Each symbol gets a Cyclic Prefix (CP) added to it, followed by windowing - one of the well-known methods of reducing spectral side lobes in OFDM. The parallel to serial block then makes the OFDM signal by sequentially outputting the time domain samples, which is also followed by digital analog conversation. A periodic extension of the last part of an OFDM symbol is the CP, which is, at the transmitter, added to the front of the symbol. Then, at the receiver, it gets removed before performing the demodulation process. To convert the linear convolution that happens with the channel impulse response into a cyclic convolution, The CP gets inserted. Then a diagonalised channel is resulted of the cyclic convolution, which turns to be ISI and ICI interference free.

To prevent inter symbol interference (ISI) on condition that its length is longer than the impulse responsible of the channel, the CP, between successive OFDM symbols, gets to act as a space guard. By keeping the OFDM symbol periodic over the extended symbol duration, the Cyclic Prefix ensures orthogonality that's between the sub-carriers, and thus having the Inter Carrier Interference (ICI) avoided. Then, through an OFDM demodulation technique, the original data gets recovered out of the modulated signal. The guard cyclic prefix gets removes as the received signal passes through a low pass filter. Then the serial data stream gets changed into parallel, FFT of the signal following it. And to get to the original signal, a demodulator is utilized. Taking into considerations the un-modulated signal and the receiving end data, a calculation is done to the bit error rate and the signal to noise ratio. That being said, a lot of problems that are done from the mismatch of oscillators or the Doppler spread caused by a relative movement between the receiver and transmitter, which include the peak-to average power ration (PAPR), time and frequency synchronization errors, constrain the OFDM. The OFDM systems performance is affected by time and frequency varying wireless channels. The Carrier Frequency Offset (CFO) done by the mismatch of frequencies between, again, the oscillators at the receiver and the transmitter cause time-varying impairments. Meanwhile, frequency-varying impairments are the outcome of the offset in timing or the delay spread of wireless channels. And even though OFDM systems have more resilience to frequency-selective fading channels, it's not the case with time-frequency varying impairments of channel, where they tend to be a little more sensitive towards. The aforementioned impairments are completely cancelable in time domain through CFO estimations.

The ICI, which is between subcarriers in OFDM systems, occurs by CFO, which proceeds in the destruction of the sub-carrier orthogonality, which in turn results into degradation of the bit error rate (BER). A phase change proportional is also introduced by CFO to OFDM symbol number, in addition to the cyclic change of data between subcarriers. Another PAPR reduction technique in OFDM systems gets focused on by that work. For the process of modulating and process of demodulating individual OFDM sub carriers, Inverse fast Fourier transform and Fast Fourier transform are used to convert the signal spectrum to the time domain for transmission over the channel and as well as using FFT on the receiving end to get data symbols in serial order. The cyclic prefix (CP) is the second key principle as Guard Interval (GI). CP saves the transmitted signal periodic. One of the reasons to use CP is to shun Inter Carrier Interference (ICI). Interleaving is one of the most important concepts used. The wireless channel may affect the data symbols transmitted on sub carriers which lead to bit errors. To face this problem efficient coding schemes were used.

**Multi path fading**

Multi path fading – unlike a wired channel, which uses a fixed path, the signals in a wireless channel can reach a user using multiple paths. All these signals known as multipath components may have different channel gain and time delay. This combined effect causes what we know as multipath fading.

**Delay spread**

Delay spread – as a consequence of multi path propagation the duration of a symbol gets extended. This may interfere with the next symbol. This is called inter symbol interference (ISI) or Cross-talk. Guard periods are introduced to avoid cross-talk.

**Frequency selective fading**

Signals having bandwidth higher than the coherence bandwidth of the channel faces variable attenuation at different frequencies, this ultimately distorts the signal and rise to frequency selective fading. Complex channel equalization techniques are employed to reduce it.

**Inter channel interference**

Often signal bandwidth of adjacent carrier frequencies overlap with each other giving rise to inter channel interference. Guard bands were introduced to avoid inter channel interference.

**Attenuation**

Attenuation is a reduction in the strength of a signal, applies to both analog and digital signals, a natural consequence of signal transmission over long distances. Also known as signal loss and Measured in decibels (dB) or watts (W). Attenuation can occur due to long cabling -both wired/ wireless transmission dissipate in strength over distance, wire sizing - on wired transmission network, thinner wires are more prone to attenuation than thicker wires , crosstalk from adjacent cabling and defective connectors and conductors.

**Convolution code**

Forward Error Correction (FEC) Coding designed so that errors can be corrected at the receiver. Convolution codes work on the incoming message sequence continuously in a

serial manner. A convolutional code has three parameters (n, k, m), where k/n represent coding rate and determine the number of data bits per coded bit and m represent the constraint length of the encoder where m-1 represent memory elements of the encoder.

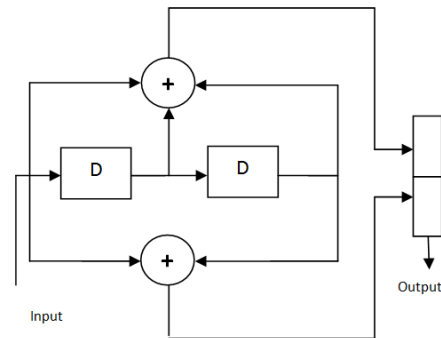

Figure 5 A (2, 1, 2) Convolution encoder

		States
—————	1 input	S0 = 00
-----	0 input	S1 = 01
		S3 = 10
		S4 = 11

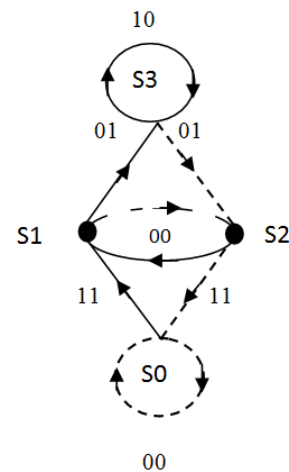

Figure 6 State Diagram for the (2, 1, 2) Convolutional Code

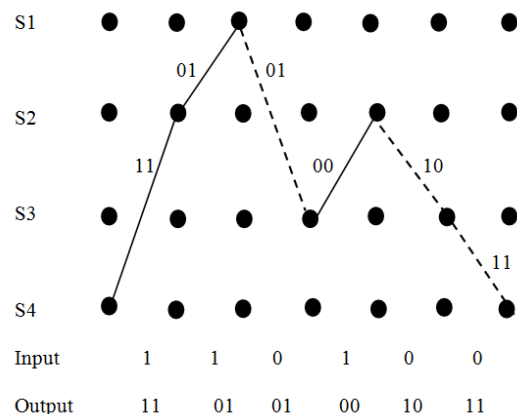

Figure 7. Trellis when encoding input = (1101)

Bit error rate is a performance criterion of digital data transmission which is defined as

$$BER = \frac{\text{Number of Error Bit}}{\text{Number of Total Bit}} \quad (1)$$

Another important performance measurement which is commonly used in transmission is SNR. For example. signal to noise ratio which is defined as

$$SNR = \frac{\text{Signal Power}}{\text{Noise Power}} \quad (2)$$

SNR measure is inversely proportional to BER. It means least BER or higher SNR ensure better quality of communication. In order to detect and correct the error produced during transmission; generally Forward error correction technique is generally used. Convolution codes and block codes are two different Forward error correction techniques which are commonly used.

### Convolution decoder

Decoding convolutional codes have two basic types to. Which are sequential decoding and maximum likelihood decoding depend on Fano algorithm and Viterbi algorithm respectively. Viterbi decoding was used in this paper because is an efficient and practical decoding for short constraint lengths. It's used to correct error and fully based on the Trellis structure. This decoding has two major parts: Metric value: it's as like a hamming distance for example Number of bits to be changed and this value to added in a previous node metric value also this value is called metric value. Survivor path or active path: in each node after the 2<sup>nd</sup> stage two paths to be entering; this node has two metric values. The path lower metric value is retained and the other path is discarded. This retained path is called as survivor path or active path.

### Algorithm Steps

**Step 1:** First stage and second stage as like a trellis. Finding the metric value for each node (Metric value to be find with help of received bits to compare the coded bits). In initial node metric value becomes zero.

**Step 2:** after the stage 2 each node receiving to path, each path having a single metric value therefore after the second state each node have 2 metric values.

**Step 3:** Find the survivor path with help of minimum metric value (Minimum metric path only retained others are discard)

**Step 4:** step 2 and step 3 are repeat until the received bit sequence stop.

**Step 5:** Finally find active path. This active path code word is the corrected code word and finds the original message sequence.

### Communication channels

#### AWGN Channel

When noise satisfies these three criteria's ( Additive , White and Gaussian) it's known as Additive White Gaussian Noise such a channel is known as AWGN channel and consider one of the most popular models AWGN channel is not related with

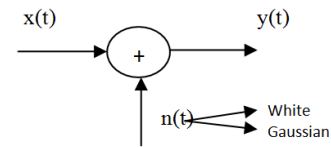

Figure 8. AWGN Channel

either fading or any other system parameters. It is just the noise that is added to the OFDM modulated signal when it is travelling via the channel. The below equation shows capacity of AWGN Channel

$$C = \frac{1}{2} \log \left( 1 + \frac{P}{N} \right) \quad (3)$$

Where C represents channel capacity while P and N represents signal power and noise respectively. High data rate communication through additive white Gaussian noise channel (AWGN) is limited by noise. The received signal in the interval  $0 \leq t \leq T$  may be

Showed as

$$\lim_{n \rightarrow \infty} \left( 1 + \frac{1}{n} \right)^n R(t) = Sm(t) + n(t) \quad (4)$$

Where, n(t) represents the sample function of additive white Gaussian noise (AWGN) process with power spectral density.

### Rayleigh Fading

Rayleigh fading is a model that can be used to describe the form of fading that happens when multipath propagation exists. In any terrestrial environment a radio signal will travel through a number of different paths from the transmitter to the receiver. The most obvious path is the direct, or line of sight path. The Rayleigh propagation model is most appropriate to cases where there are several different signal paths, none of which is dominant. In this situation all the signal paths will vary and can have an effect on the whole signal at the receiver.

Table The Convolution code OFDM simulation parameters

Parameter	Value
Subcarriers	64
Convolution code	Half rate with P(133,171)
Size of IFFT	64
Digital Modulation	8-QAM 16-QAM 32-QAM 64-QAM
Signal to noise ratio	(0-50)dB
Size of frame	96-bits
Number of Frames	1000
Number of pilots	4
Cyclic prefix	(16) 25%
Channel fading	Rician, Rayleigh and AWGN

Simulation of Algorithm Steps:

**Step 1:** Generate 96000 bits arbitrarily by using this command randint (96000, 1).

**Step 2:** Encode bits by using a convolutional encoder with the specified (133,171) poly2trellis matrix to encode the information bits.

**Step 3:** Interleaving coded data and determine number of bits that it use in modulation

**Step 4:** Binary to decimal conversion.

**Step 5:** Type of modulation.

**Step 6:** Pilot insertion to modulated data.

**Step 7:** Generate OFDM signals by using IFFT, total 1000 frames are generated size of each frame is 96-bits.

**Step 8:** Adding Cyclic Extension.

**Step 9:** Generate noise to simulate channel errors. In this paper signals are transmitted through Rayleigh and AWGN channels.

**Step 10:** At the other side, repeat opposite operations to get final data.

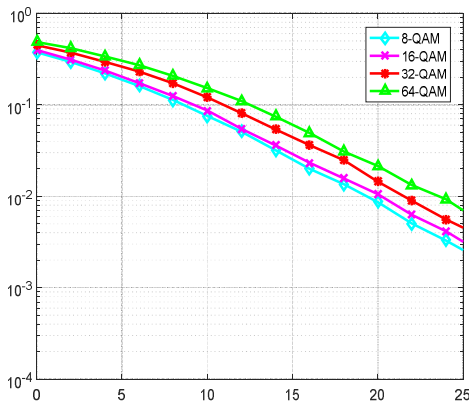

**Figure 10.** BER vs. SNR for Convolutionally coded OFDM system using QAM Modulation over Rayleigh channel before decoder

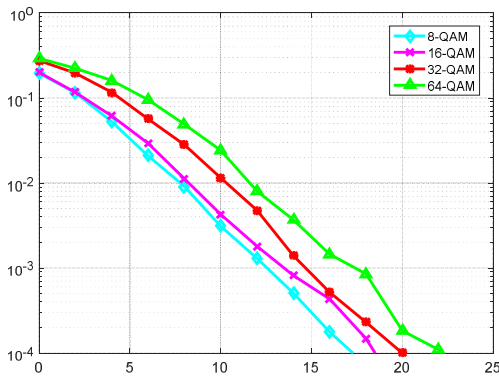

**Figure 11.** BER vs. SNR for Convolutionally coded OFDM system using QAM Modulation over Rayleigh channel.

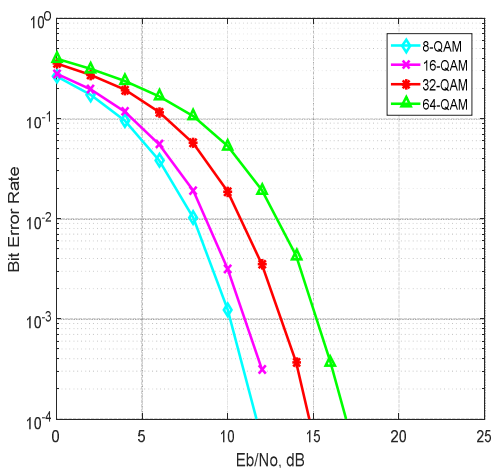

**Figure 12** BER vs. SNR for Convolutionally coded OFDM system using QAM Modulation over AWGN channel before decoder

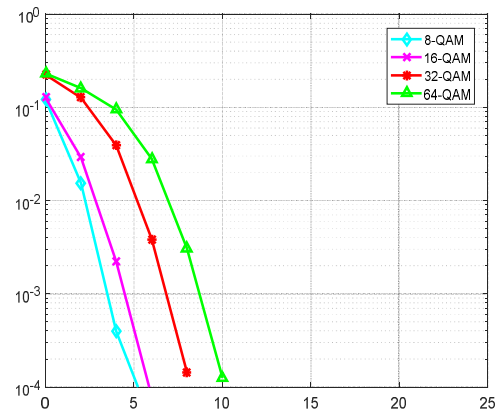

**Figure 13** BER vs. SNR for Convolutionally coded OFDM system using QAM Modulation over AWGN channel

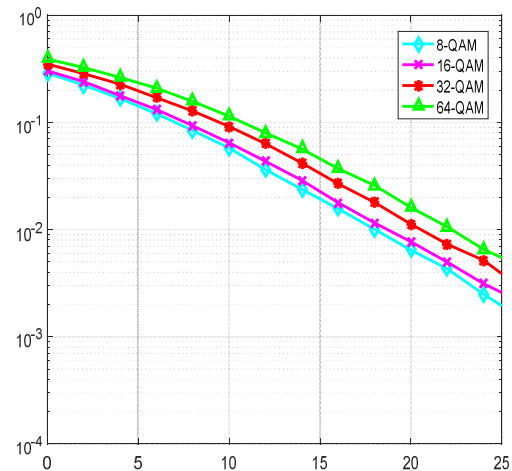

**Figure 14** BER vs. SNR for Convolutionally coded OFDM system using QAM Modulation over Rician channel before decoder

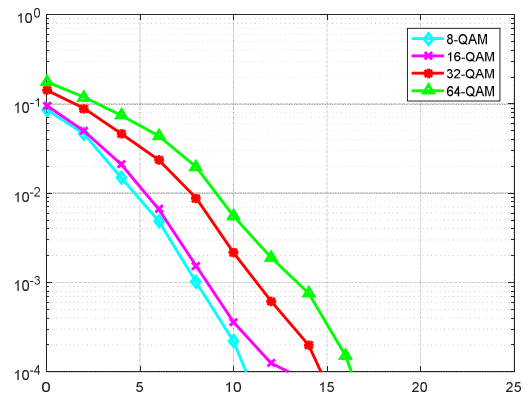

**Figure 15** BER vs. SNR for Convolutionally coded OFDM system using QAM Modulation over Rician channel

**Conclusion**

Bit error rate performance of an OFDM using convolutional channel coding and different digital modulation schemes has shown in this work. 1000 frames of OFDM system with 96 bit length of each frame, 4 pilots as well as 25% cyclic prefix used three different channels were used in this paper. Different concepts of wireless communication discussed as well as concept of convolution code. We compare the performance of BER before and after decoder by using several modulation techniques on AWGN, Rayleigh and Rician Channel. Time-invariant frequency selective channel, How the convolution code coded data, Viterbi which is a function of several

parameters trace-back-length, hard or soft decision decoding, code-rate and using interleaver all these parameters were played well to get good performance. Simulation result shows that AWGN gives the better performance when compare with Rayleigh and Rician channels, While Rician gives performance better than Rayleigh channel.

## REFERENCES

- Charles Herach Papas. 1965. Theory of Electromagnetic Wave Propagation.
- Heung Gyoon Ryu, Tran Phuong Hoa, Nguyen Thanh Hieu, Jin Jianxue. BER Analysis of Clipping Process in the Forward Link of the OFDM-FDMA Communication System. November 2004; 4: 0098-3063.
- Juha Korhonen, 2003. 2nd ed, Introduction to 3G Mobile Communications.
- Maruf Bhuyan, N. H., Jia Uddin, Monirul Hoque, Md.Ahasan Habib. 2012. Performance Analysis of Wi-MAX:Modulation Scheme Versus Bit Error Rate. dec- 4: 2230-7109.
- Mhd Omar Nader, Dr. Nizar Zarka, 2015. The 4th and 5th Generation of Mobile Network.
- Nasimul Hyder Maruf, Mamun Ahmed, Mohammed Faisal, Mohammad Salauddin. Bit Error Rate Performance Analysis of Convolutional Coded Orthogonal Frequency-Division Multiplexing System. 2016 ; 978-1-5090-3731-5.
- Prajoy Podder, Tanvir Zaman Khan, Mamdudul Haque khan, M. Muktedir Rahman. 2014. Ber Performance Analysis of ofdm-bpsk, qpsk, qam Over Rayleigh Fading Channel & Awgn Channel. June 978-93-84209-23-0.
- Prakash Kumar, R. 2014. Improving the Bit Error Rate of OFDM using Convolutional codes. November 2.
- Sai Krishna Borra, Suman Krishna Chaparala, 2013. Performance Evaluation of OFDM System with Rayleigh, Rician and AWGN channels. March 3: 2250-2459.
- Salvatore gravano, 2001. Introduction to Error Control Codes. March
- Saroj Singh, Sagar Singh Rathore, 2014. Simulation and Analysis of Convolution-Coded OFDM under AWGN Noisy Channel. August- 8: 2278-0181.
- Wong & Lok. 2000 Theory of Digital Communications.

\*\*\*\*\*