



ORIGINAL RESEARCH ARTICLE

OPEN ACCESS

## ECONOMIC FEASIBILITY, PROFITABILITY AND MATHEMATICAL ANALYSIS OF 432 KW ROOFTOP SOLAR PHOTOVOLTAIC POWER PLANT

<sup>1,\*</sup>Ashish kumar, <sup>2</sup>Dr. Kesari, J.P. and <sup>3</sup>Prof. Mishra, R.S.

<sup>1</sup>M.Tech (Renewable Energy Technology), Delhi Technological University, New Delhi

<sup>2</sup>Former AICTE Director, Associate Professor, Delhi Technological University, New Delhi

<sup>3</sup>Head of the Department (HOD), Mechanical department, Delhi Technological University, New Delhi

### ARTICLE INFO

#### Article History:

Received 18<sup>th</sup> June, 2017  
Received in revised form  
19<sup>th</sup> July, 2017  
Accepted 24<sup>th</sup> August, 2017  
Published online 30<sup>th</sup> September, 2017

#### Keywords:

Solar PV,  
Mathematical analysis,  
Economic feasibility,  
Delhi Technological University,  
432 KWp, Rooftop SPV Power Plant.

### ABSTRACT

Energy plays a key role in both the economic growth & prosperity of the country. It determines the pace of development of the developing countries. There is a close relation between the Energy & future growth of a nation. Not only in India but also in the whole world, there is a never-ending and diverging need for energy. Since, ancient times, the energy are derived from one source or another. In much older periods, the demand for light & fuel was met with traditional sources like wood or animal dung or waste plants. Later they got replaced by coal, water & nuclear energy which were then available in abundance. But, as the time goes on, the limitations & drawbacks are stepping forward making the hunt for alternative sources of energy a must, considering the future generation & their needs with a long term vision. As its high time to think upon the quality of the environment, more and more awareness is generating for making the use of the environment friendly resources and products. Though sunlight is considered to be a "convincing solution" to the "need for clean, abundant, cheaper, renewable and environment friendly source of energy," solar energy currently provides only about 0.01 percent of the total electricity supply needs; this indicates the huge scope of solar SPV in a sub-tropical country like India and rest of the world. When compared to conventional and other renewable energy sources, solar power is especially attractive because it can be easily scaled up Solar electricity can also be generated nearer to consumers and even on site, which greatly reduces or eliminates transmission costs and losses. Further, Ministry of New & Renewable Resources (MNRE) and the Ministry of Power (MoP), Govt. of india has an obligation to promote and support co-generation technologies and renewable sources for Power generation under the supervision of Nodal agencies and henceforth it will play a major role in mainstreaming renewable energy sector with other conventional energy sources in India. In view of the efforts of government and favorable government policies in renewable sector has compelled various agencies and institutions to look forward in this regard. Delhi technological University has took a step forward and decided to have a SPV rooftop system of 432 KW power. Assuring robust project design, reliability and best support, M/s Hero Future Energies Limited got this opportunity to implement a 432 kW SPV power Plant under the supervision and guidance of the esteemed professors on the rooftops of the buildings of the Delhi Technological University. This research work brings out the technical details & overall cost mitigating this pioneer project. The total power to be produced by the solar cells will be 432 kW. The cell technology, which is being used, is crystalline type. The main objective of this project is to study the economic feasibility and practicality of the of the rooftop solar power systems of these type of SPVs.

#### \*Corresponding author

Copyright ©2017, Ashish kumar et al. This is an open access article distributed under the Creative Commons Attribution License, which permits unrestricted use, distribution, and reproduction in any medium, provided the original work is properly cited.

Citation: Ashish kumar, Dr. Kesari, J.P. and Prof. Mishra, R.S.. 2017. "Economic feasibility, profitability and mathematical analysis of 432 kw rooftop solar photovoltaic power plant", *International Journal of Development Research*, 7, (09), 14951-14967.

### INTRODUCTION

The Indian electricity sector deliveries the world's sixth biggest energy end user, which accounts for about 3.4 percent of the total worldwide energy consumption by greater than

17% of worldwide population. The Energy sector guidelines and policies in India is principally governed and formulated by the Ministry of Power, Ministry of Coal and Ministry of New and Renewable Energy Government of India, and controlled

locally by Public Sector Units. Thermal Power plants (TPPs) accounts for about 70% of the electricity used up in India, hydroelectric power plants (water turbines) are generating 21% and another 4% by nuclear power plants (nuclear reactors). As on 31 March 2017, in India, the mounted capacity of power plants is 3,30,260 Mega Watts and the amount of net electricity produced by power plants is 1106 billion kWh, which also contains power required to run auxiliary/supporting equipment and devices attached with power generating units.

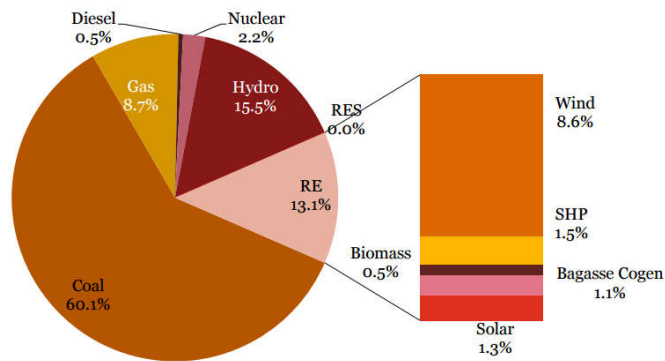

Figure 1.1. Share of energy resources

The mounted capacity of captive power plants (CPPs) in industries (equal to and more than 01 MW) is 47,080 MW and produced 165.426 billion kWh during the 2014-15 financial year. Further, there are about 75,000 MW comprehensive capability of diesel generators (DG Sets) with unit's sizes varying in the range of 100 KVA to 1000 KVA. The per-capita consumption of Electricity in India is near about 1015 kWh during 2014-15 financial year. In terms of demand, more than fifty percent of commercial energy demand is fulfilled through the country's giant coal reserves. In recent years, India has also capitalized huge in renewable energy utilization, especially in field of wind energy. India's installed wind generated electric power was 25088 MW as on 31/03/2017. Moreover, India has dedicated huge sum of capitals for erection and development of many nuclear reactors, which may generate minimum thirty thousand megawatt. Further, India revealed \$19 billion plan to generate twenty thousand megawatt of solar power by the year 2020 in July 2009. Due to rapid growth of Indian economy, the energy demand has grown with an average of 3.6 percent per annum over the period of past 30 years. The total energy demand for electricity in India is expected to cross 9,50,000 MW by year 2030.

**The total power generated from different sector is tabulated below:**

These days the focus of the energy sector has been shifted from energy production to clean energy production, which is only possible to achieve by, utilize the potential of renewable energy resources like solar energy, nuclear energy and wind energy etc.

#### Renewable Energy Potential and Achievement in INDIA

India is fronting severe energy scarcity, which in turn obstructing its economic progress and industrial growth. Also, the construction and installation of new power plants is surely reliant on the import of high quality fossil fuels like coal etc. Thus, it has become vital to cure the energy crunch through sensible consumption of plentiful renewable energy resources, like solar energy, Biomass energy, Geothermal energy and Wind energy.

In addition to enlargement of the energy supply, renewable resources will assist India in justifying climate change. In current scenario, India is severely reliant on the exploitation of fossil fuels for its energy demands. A large crunch of power generation is done by coal based mineral oil-based power plants and, which add greenhouse gases to the atmosphere and hence, enhance the phenomenon of Global Warming. As compared to developed countries like USA, Europe, Japan, Australia, etc., the average per-capita consumption of energy in India is only 0.5 KW, which is far below in comparison of other countries. However, this figure is likely to grow rapidly due to rapid industrialization and high economic growth. The demand of electricity is increasing on the world-wide basis.

#### Nuclear Power in INDIA

Presently, total 4,780 MW power is being produced by 20 nuclear power plants. These facts indicates that renewable energies in India is quietimmature. There is a fact that in early 1980s, India is the first country in the world to set up a ministry of non-conventional energy resources. Though, its success is not up to the mark. In present scenario, India has been lagging behind other countries in terms of the usage of renewable energy. The share of RE in the energy sector is less than 1% of India's total energy needs. Renewable energy sector in India comes under the Ministry of New and Renewable Energy (MNRE).

#### Wind Power in INDIA

In early 1990s, the development of wind energy started in India and has significantly increased in the past few years. When compared to rest of the world, India is having 5<sup>th</sup> largest installed wind power capacity in the world. As of June 2010, in India the installed capacity of wind power was 12009.14 MW, mostly extent across Tamil Nadu-4132.72 MW, Maharashtra-1837.85 MW, Karnataka-1184.45MW, Rajasthan-670.97 MW, Gujarat-1432.71 MW, Andhra Pradesh-122.45 MW, Madhya Pradesh-187.69 MW, Kerala-23.00 MW, West Bengal-1.10 MW, other states-3.20 M). It is predictable that 60,000 MW of wind power plant will be installed in India by 2022. Wind power generates only one point six percent of the country's power and accounts for six percent of India's total power capacity installed.

#### Solar power achievements and potential in INDIA

India is heavily populous and also receives high solar radiations (avg. 1000W/m<sup>2</sup>), which is a perfect recipe for exhausting solar power in India. Many areas of the country are not connected with electrical grid power supply mainly rural and remote areas, hence one of the possible applications of solar power has been for operating water pumps, which could replace India's 4-5 million diesel powered water pumps, each consuming about 3.5 KWs, and off-grid lighting. Some big projects have been proposed, and a thirty five thousand square kilometer area of the Thar Desert has been set aside for solar projects, adequate to generate 700 - 2,100 GW. The Solar Loan Programme in India, supported by the United Nations Environment Programme (UNEP) has won the esteemed Energy Globe World award for Sustainability for helping to establish a consumer financing program for solar home power systems. Over the duration of three years, more than sixteen thousand home solar systems have been financed through two thousand bank branches, mainly in rural areas of Southern India where the electricity grid does not yet extend.

Energy is a necessity and sustainable renewable energy is a vital link in industrialization and development of India. To meet the ever increasing energy demands and to address environmental concerns a transition from conventional energy systems to those based on renewable resources is necessary. India is having an intense potential for exploitation of renewable energy resources (RE), an estimated total of over one lakh megawatt power. Thereafter, the scope for generating electric power and thermal applications using solar energy is enormous. Though, only a fraction of the united potential of renewable resources particularly solar energy, has been exploited so far. Therefore, India to achieve its clean energy aim has to increase the utilization of intense prospective of solar power in India. The present Power Scenario of India give the idea of break-up of energy generation from renewable energy resources. The present scenario of renewable energy in India as on 31<sup>st</sup> March 2017 and future revised targets are given below:

Hence, it is required to use this potential to obtain cleaner and cheap energy. The effect of revised targets for renewable energy is shown below in figure: However if we consider the potential of different renewable energy sources in India, then it may be analysed that solar power is at the top. As per the MNRE Annual Report 2015-2016, the state/UT-wise power potential for different renewable resources in India is as follows: The total potential for solar power in India is 7, 48,990 MW which far more when compared to other renewable energy sources. The only need to utilize such a high potential of solar power, we need to create awareness, increase efficiency of solar panels, provide & affordable availability of solar PV to common men, reduce size/KW of power generation etc. Moreover, government policies needs to be biased towards this sector in order to give a boost.

**Review of Literature**

**Various Literature Reviewed**

Zhang, D. Jing, L. Zhao, J. Wei, and L. Guo, have done a comparative test to find out the thermal energy saved by using the PV/T system instead of using solar PV and solar thermal separately (Zhang et al., 2012)

The hybrid photovoltaic and thermal (PV/T) system can utilize solar energy more effectively and has a higher total efficiency compared with a traditional solar collecting system and a photovoltaic (PV) module. However, there is limited experimental data on how much energy the PV/T system can save when operating with same area of a PV plate and a solar collector simultaneously. In this paper, a comparative test rig had been set up to measure and analyze the performance of PV/T system. There were monocrystalline silicon PV/T solar collector, a traditional solar collector and a monocrystalline silicon photovoltaic plate. The PV/T collector and the traditional solar collector had the same collecting areas and solar cell covered area of the PV/T collector was the same as the area of the photovoltaic plate.

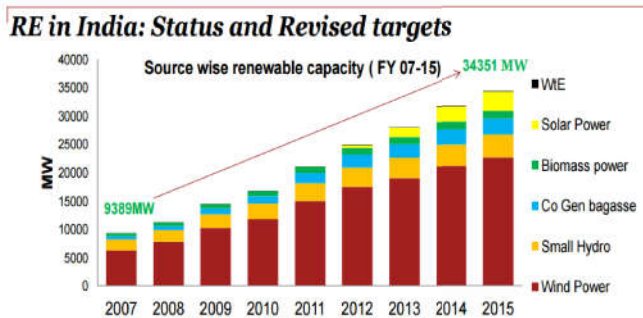

Figure 1.2. Status and targets of Renewable Energy in India

Even though India has a huge potential of solar power the above data shows that the solar power in India has very deliberate development in the last few years.

Table 1.1: Total installed Power Generation Capacity (till March 2017)

Power Sources	TPPs Capacity (MW)	Percent (%)	Captive Power (CPPs) Capacity (MW)	Percent (%)
Coal	195,602.88	59.12	27,588.00	58.60
Hydro-electricity	44,594.43	13.3	83.00	0.17
Renewable energy (RE)	57,260.24	17.33	-	-
Gas	25,185.38	8.41	5,215.00	11.08
Nuclear	6,780.00	2.05	-	-
Oil	837.64	0.253	14,196.00	30.17
Total	3,30,260	100	47,082.00	

Table 1.2: Installed power capacity in various sectors

Power Sector	Utility Power Capacity (MW)	Percent (%)
State Sector	104,303.28	31.58
Central Sector	81,167.25	24.58
Private Sector	1,44,790.01	43.84
Total Power	3,30,260	100

Table 1.3. Installed Capacity in MW

Capacities in MegaWatt				
Source	Installed capacity as on Mar 2012	Installed capacity as on Mar 2015	Installed capacity as on 12 <sup>th</sup> plan (Mar 2017)	Targets till 2022
Solar Power	941	3,383	12,288	1,00,000
Wind Power	17,352	22,645	32,279	60,000
Biomass	3,225	4,183	8,182	10,000
Small hydro	3,395	4,025	4,379	5,000
TOTAL	29,914	34,351	57,128	1,75,000

175 GW RE will contribute to 18.9% of the entire power consumption in India in 2022

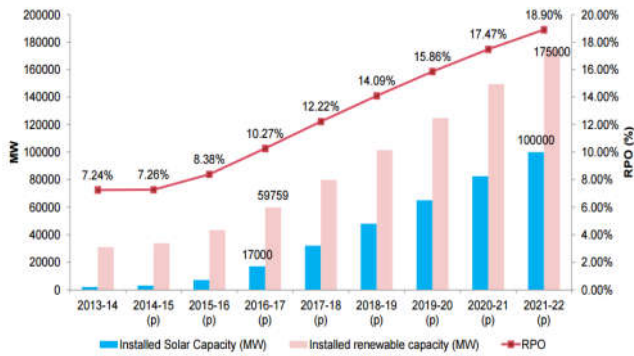

Figure 1.3. Comparison of solar power growth in INDIA

The experimental results showed that the daily thermal efficiency of PV/T system was about 40%, which was about 75% of that for a traditional solar thermosiphon system, and the daily average electrical efficiency was found about 10%, which was a little lower than the photovoltaic module. But primary-energy saving efficiency of the PV/T system was much higher than that of the individual PV plate and the traditional solar collector.

Priscila Gonçalves Vasconcelos Sampaio, Mario Orestes Aguirre González have done analysis which shows that studies about photovoltaic energy are rising and may perform an important role in reaching a high-energy demand around the world (Sampaio et al., 21017).

The purpose of this article is to understand the state of art of photovoltaic solar energy through a systematic literature research, in which the following themes are approached: ways of obtaining the energy, its advantages and disadvantages, applications, current market, costs and technologies according to what has been approached in the scientific researches published until 2016. For this research, we performed a qualitative and quantitative approach with a non-probabilistic sample size, obtaining 142 articles published since 1996–2016 with a slitting cut. The analysis result of this research shows that studies about photovoltaic energy are rising and may perform an important role in reaching a high-energy demand around the world. To increase the participation of photovoltaic energy in the renewable energy market requires, first, to raise awareness regarding its benefits; to increase the research and development of new technologies; to implement public policies a programs that will encourage photovoltaic energy generation.

Table 1.5: Potential of all renewable energy sources in India in Megawatts

S. No.	State/UTs	Wind Power	Small Hydro Power	Biomass Energy			Solar	Total
				Biomass power	Bagasse Co-generation	Waste to energy		
1	Andhra Pradesh	14497	978	578	300	123	38440	54916
2	Arunachal Pradesh	236	1341	8			8650	10236
3	Assam	112	239	212		8	13760	14330
4	Bihar	114	223	619	300	73	11200	12559
5	Chhattisgarh	314	1107	236		24	18270	19950
6	Goa		7	26			880	912
7	Gujarat	35071	202	1221	350	112	35770	72726
8	Haryana	93	110	1333	350	24	4560	6470
9	Himachal Pradesh	64	2398	142		2	33840	36446
10	Jammu & Kashmir	5685	1431	43			111050	118208
11	Jharkhand	91	209	90		10	18180	18580
12	Karnataka	13593	4141	1131	450		24700	44015
13	Kerala	837	704	1044		36	6110	8732
14	Madhya Pradesh	2931	820	1364		78	61660	66853
15	Maharashtra	5961	794	1887	1250	287	64320	74500
16	Manipur	56	109	13		2	10630	10811
17	Meghalaya	82	230	11		2	5860	6185
18	Mizoram		169	1		2	9090	9261
19	Nagaland	16	197	10			7290	7513
20	Odisha	1384	295	246		22	25780	27728
21	Punjab		441	3172	300	45	2810	6768
22	Rajasthan	5050	57	1039		62	142310	148518
23	Sikkim	98	267	2			4940	5307
24	Tamil Nadu	14152	660	1070	450	151	17670	34152
25	Telangana						20410	20410
26	Tripura		47	3		2	2080	2131
27	Uttar Pradesh	1260	461	1617	1250	176	22830	27593
28	Uttarakhand	534	1708	24		5	16800	19071
29	West Bengal	22	396	396		148	6260	7222
30	Andaman & Nicobar	365	8				0	373
31	Chandigarh					6	0	6
32	Dadar & Nagar Haveli						0	0
33	Daman & Diu	4					0	4
34	Delhi					131	2050	2181
35	Lakshadweep						0	0
36	Puducherry	120				3	0	123
37	Others					1022	790	1812
	Total	102772	19749	17536	5000	2554	748990	896602

Although crystal silicon solar cells were predominant, other types of cells have been developed, which can compete, both in terms of cost reduction of production, or in terms of greater efficiency. The main applications are dominated by telecommunications, water pumping, public lighting, BIPV, agriculture, water heating, grain drying, water desalination, space vehicles and satellites. The studies found on photovoltaic solar energy are all technical, thus creating the need for future research related to the economic viability, chain supply coordination, analysis of barriers and incentives to photovoltaic solar energy and deeper studies about the factors that influence the position of such technologies in the market.

**Praveen, V Vijaya Ramaraju have done analysis on different materials that will add to increase efficiency of solar cells (Praveen, 2017)**

Electrical energy is one of the main resource for development of any country. As there are many ways to generate electrical energy, solar energy is one of green energy which is imperishable. As many research institutions are rigorously working on how to improve efficiency of Solar Photovoltaic cell so that we can generate more electrical energy per given area. Selection of different material such as CdTe, GaN, SiGaAs, Ge, InP, a-SiH, cSi will give variation in band gap, change in efficiency of photovoltaic cell. We need to solve supply demand problem by adding more generation. One method can be optimizing efficiency of solar cell by making multi-layer, multi junction with more materials which can effectively use complete solar spectrum to convert as electricity by changing band gap limits. This paper will present how different material will add to increase efficiency of solar cells. Another important reason for research towards improve in solar photovoltaic cell efficiency is rapid reduction of availability of conventional energy resources such as coal, oil and gas.

**Lingkun Liu, Yaxue Lin, Guruprasad Alva, Guiyin Fang have done research in the field of photovoltaic-thermal collector (Lingkun Liu et al., 2017).**

In a photovoltaic–thermal solar collector, only a small percentage of the absorbed solar radiation can be converted into electricity, the rest is converted into heat. The waste heat gathering and transferring rate is the key to improve the module efficiency. In this work, a type of microencapsulated phase change slurry was employed in the photovoltaic–thermal solar collectors to improve the thermal and electrical performances. The designed photovoltaic–thermal collector was reduced to a 2–dimension physical model and numerically studied. Solar cells temperature, outlet temperature and pressure drop of the fluid, electrical, thermal and overall net efficiency were simulated and analyzed to evaluate the dynamic performance of the hybrid photovoltaic–thermal collector. Energetic efficiencies for photovoltaic–thermal model with various light concentrations versus the mass flow rate of the microencapsulated phase change slurry flow were investigated. When the concentration is 10 wt%, the photovoltaic–thermal collector obtained the highest net efficiency with the flow rate of 0.02 kg/s and the piping height of 10 mm. And it was found that the temperature variation of both fluid and PV cells employing microencapsulated phase change slurry was much smaller than water, which would improve both thermal and electrical performances. Then the

optimized photovoltaic–thermal module was simulated in a daytime with the comparison of conventional water type. It was found that overall net efficiency of the photovoltaic–thermal collector with microencapsulated phase change slurry reached 80.57% at 11:00, about 1.8% higher than the conventional water type. The maximum overall net exergy efficiency was 11.4% in the morning. Above all, the proposed photovoltaic–thermal collector with microencapsulated phase change slurry flow has potential for further development in solar collector

**Nouran M.AliOpens, Nadia H.Rafat have done research in the field of different analytical modelling techniques and different numerical simulations of Nano rods PV solar cells that were published in the last 11 years (Nouran et al., 2016).**

In response to the massive focus on the fabrication of nanorods (NRs) and nanowires (NWs) based photovoltaic (PV) solar cells, having analytical models or numerical simulators for them has become a hot topic in the researches over the past few years. The structures of NRs and NWs solar cells can solve the carrier collection problems that face the conventional planar solar cells and can help in trapping light in the cell. Also, the radial geometry improves tuning band gap, relaxing facile strain, and increases defect tolerance. These advantages enable the PV solar cells to achieve high conversion efficiency with a relatively low cost. NRs and NWs solar cells' modelling and simulation enable the estimation of the cells performance and characteristics such as the efficiency, fill factor, short circuit current and open circuit voltage. This review summarizes different analytical modelling techniques and different numerical simulations of Nano rods PV solar cells that were published in the last 11 years. The structure of the PV cell includes p-n concentric cells, p-i-n concentric cells, branched NWs cells, axial horizontally oriented cells, and axially connected p-n junction cells.

### Research Gap

Although these works have been done outside and inside India. However, still lot of demonstrative works remain to be done in India, which will help India to utilize efficiently its full potential of renewable power. After reviewing the above literature the following research gap is found;

**Engineering Problem:** There are a billion people worldwide without access to electricity, and it would be extremely expensive and environmentally harmful to try to connect all those people to the grid.

**Engineering Goal:** This project aims to modify a solar panel in such a way that would improve the efficiency of an individual solar panel installed at rooftop of buildings and commercial complexes due to reduced shadow effect, thereby reducing the number of solar panels needed to power a given household and reducing the cost. And, also to explain the practical feasibility of rooftop solar photovoltaic system.

### Objectives of Present Work

The main objective of this project is to study the economic feasibility and practicality of the of the rooftop solar power systems. Now days we are in the era of rapid development, which require exponential growth of energy demand. Due to this increasing energy demand the burden on fossil fuels is

rising which is a major concern for the sustainable development and healthy environment. Therefore, to avoid this huge concern a way out is to be required some reliable, renewable and clean energy sources is required. Solar power is one the best solution of this problem and must be focused to make it more practical and accessible to the common people. Keeping this thing in mind this particular project related to 432 KWp rooftop solar photovoltaic power plant installed at the campus of Delhi Technological University is chosen so as to enhance the understanding in the practicality of the PV modules and to analyse their design and feasibility in the real world.

As we, all are aware that government is also serious in this regard & has taken many game changer decisions in this field like subsidised solar panels, industry favoured policies for the SPV manufacturers etc. Government of India has recently started JNNSM program to promote solar projects in India. Under this program, many policies are coming in MW scale project as well as in roof top level. Most of industries are running on conventional sources like coal-based energy, diesel sets etc. According to this policy, any industry, commercial, domestic can plan to set up a solar project for their captive consumption. For this purpose, they can use their un-utilized space like space available on roof, sheds, BIPV etc. Till the time all rooftop policies are for captive consumption only. Some of state governments have started some initiatives for net metering policy. Under this scheme, if any solar project has excess generation (which is more than their individual load demand), they can feed that generation to utility grid. This scheme will take some time to finalize. All solar projects that are to be implemented under this policy will be mounted on roofs; sheds etc. only and total power generation from solar will be used in-house only. There is a huge potential available for generating solar power using unutilized space on wastelands, shedding and rooftops around buildings. In fact, small quantities of power generated by each individual household, industrial building complex, commercial building complex or any other type of building can be utilized to partly fulfil the power requirement of the building occupants and surplus, if available, can be fed into the grid. The rooftop SPV systems on building's rooftops can be installed to substitute DG'S for operation during load shedding. As an advantage setting up the grid interactive solar power plants on the rooftops would help in reducing the consumption of diesel fuel during the day time in the areas where grid power is intermittent. If the grid power is continuous, the solar power generated will be utilized along with the grid power and accordingly the proportionate amount of grid power usage will be reduced.

During minimum load periods (e.g. during weekends, holidays etc.), the excess/surplus power generated from solar systems (SPVs) could be fed into the grid. In turn, the State Government can compensate the consumer for the exported/traded power as per policy. Connectivity of these projects to the grid also has to be in agreement with the prevailing CEA guidelines or policy by the State regulators/ DISCOMs. The work for making DTU a clean energy developing university was assigned to M/s Hero Future Energies Pvt. Ltd. who is pioneer in this field. Delhi Technological University (DTU) until 1962, the college was under the direct control of Ministry of Education, Government of India. But, in 1963 the administration/command of the college was handed over to Delhi Administration. Delhi College of Engineering (DCE) was under the direct

administrative control of Department of Technical Education & Training, Govt. of NCT of Delhi. For academic purposes, the college was initially affiliated to University of Delhi since 1952. Whereas, from July 2009, the Delhi College of Engineering (DCE) has become Delhi Technological University (DTU) vide Delhi act 6 of 2009.

The erstwhile Delhi College of Engineering has functioned/operated from its historic Kashmiri Gate Campus for about 55 years and has shifted in 1996 to its lush green sprawling campus of 164 Acres at Bawana Road, adjoining Sector-17, Rohini, Delhi-110042. Its shifting to its new campus has added new dimensions of research and triggered innovations in plenty, which has received high national and international acclaim. As Delhi Technological University (DTU), it has the desired self-sufficiency to outshine and shape itself as a world class Technological University. Now DTU is heading towards the green and clean energy university title. Therefore, it was decided to conduct detailed study on this rooftop SPV system to analyse its mathematical analysis, feasibility and profitability.

### Solar Photovoltaic System Design and Integration

The strategic planning and methodology followed in the solar rooftop project in order to save time and timely execution of project involves following activities:

**Pre-Feasibility:** This exercise came up with basic details of site i.e. area available, load details, evacuation scheme, shadow impact etc. Number of site visits and surveys done by engineers of M/s HERO Future Energies Private Limited in the DTU Campus to get the following details for designing the rooftop SPV system and completed this work.

- Area available
- Load Details
- No. of Site visits
- Shadow impact- spacing is kept so as to minimize the shadow Effect. Shadow analysis was done by Google Sketch-up software.

### Selection of Design parameters

**The main parameters/factors considered in designing the Rooftop SPV are as follow:**

- Availability of Shadow free area/ Shadow analysis of the site
- Type and condition of Roof
- Irradiation data at project site
- Ambient Temperature at project site
- Distance of the control room from the array

### Availability of Shadow free area & Shadow Analysis

Distance between two consecutive solar PV arrays should be kept such that shadow of one array mounting structure do not falls on other mounting structure. This shadow analysis is done on Google sketch up software for 23<sup>rd</sup> March for which sun altitude is lowest in the sky for the year which will yield lowest shadows. Hence, distance is maintained minimum to obtain minimum shading losses to keep annual generation of power high. Rooftop area at the departments of DTU was found optimum for the installation of solar PV power plant.



Figure 3.1-Panel Top View

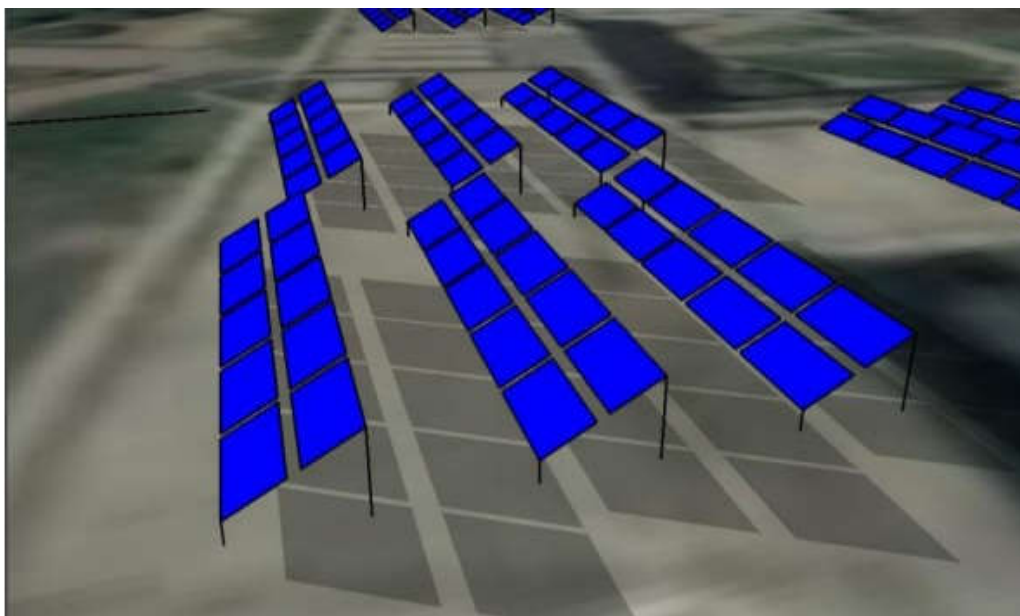

Figure 3.2-Shadow analysis

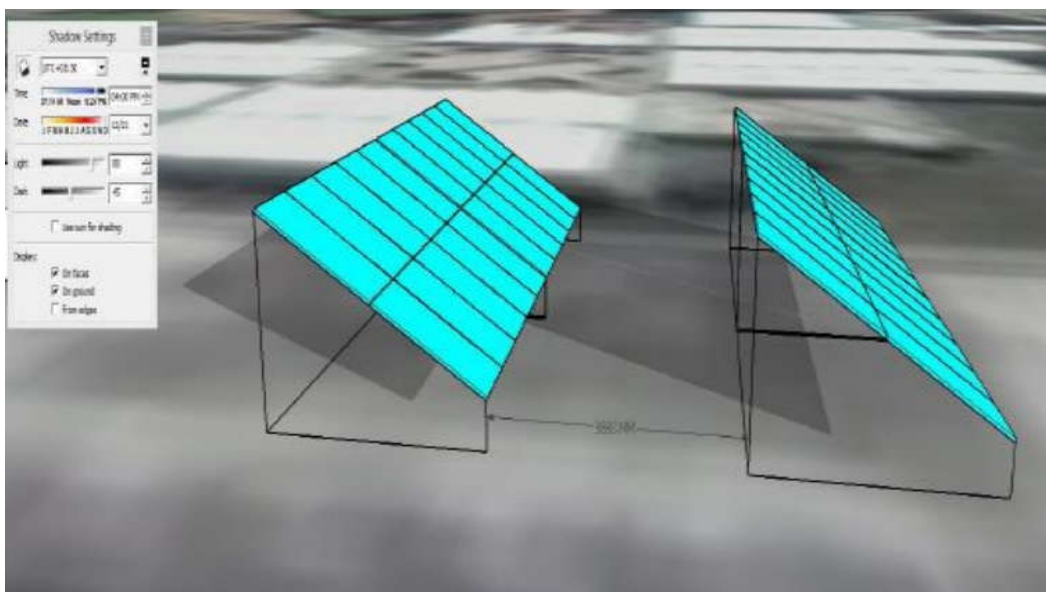

Figure-3.3. Shadow analysis on Google Sketch 3D

Simulation of shading analysis for 23<sup>rd</sup> March 2017 is shown in following figures:

**Irradiation Data at Project Site-** Data collected from MNRE website.

The Average Global Horizontal Irradiation for Delhi Region comes out to be in the range of 3.8 kWh/m<sup>2</sup> to 7.1 kWh /m<sup>2</sup>. The monthly average irradiation on ground for the site is as follows:

**Table-3.1. Monthly Average Global Horizontal Irradiation (kWh /m<sup>2</sup> .day)**

Month	Month Average Irradiation (kWh /m <sup>2</sup> .day)	Monthly Global Horizontal Irradiation (kWh /m <sup>2</sup> .day)
January	3.8	
February	4.8	
March	6.0	
April	6.8	
May	7.1	
June	6.6	
July	5.3	
August	5.2	
September	5.6	
October	5.3	
November	4.3	
December	3.7	
Average (GHI)	5.27	

**Auxiliary Parameters of the Project Site-** Data collected for ambient temperature of the site for the complete

year and average temperature for the complete year was found to be 30 C. and also the distance of control room was optimised to minimize the transmission losses.

**Engineering Approach:** In detailed engineering, complete engineering drawings, technical specifications of all components or BOM (Bill of Material) was prepared and analysed for minimum cost and maximum area cover. All engineering activities were divided into three parts.

**Electrical Engineering:** This included preparation of following things:

- String sizing based on environment conditions.
- Inverter sizing for complete project. Over sizing compatibility etc.
- Single line diagram for complete system.
- Protection scheme
- Evacuation details

**Mechanical Engineering:** This included preparation of following:

- Design of module mounting structure, this includes analysis etc.
- Preparation of structure part drawings for complete project.
- Preparation of drawing for module fixing arrangement.

**Civil Engineering:** This included preparation of following details:

- Evaluation of different type of foundation details for module mounting structure.

- Design of foundation considering wind speed etc.
- Foundation layout preparation.
- Complete project layout preparation.
- Earthing scheme design for project considering electrical parameters.

**Solar PV System & Components**

**Basic Components for Solar PV systems are:**

- Solar PV Modules
- Grid interactive Inverter along with Data logger
- Module mounting structures
- Energy Meter and Cables
- Junction Boxes and Distribution Boards
- Earthing and Lightning protection

Number of Modules combined to form an array using series and parallel configuration. The strings coming out of the array combined into an Array Combiner Box or Junction Box. The output of the Array Junction Box further connected to DC Distribution Board. Then, the DCDB output is directed to an inverter for conversion DC to AC Power and make it suitable for feeding loads & transmission to local LT supply. Block diagram of a grid connected solar P-V power plant along with various losses occurring at various levels is shown in following figure:

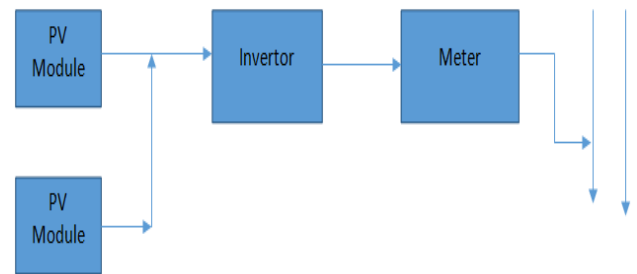

**Figure 3.4. A typical Grid connected system**

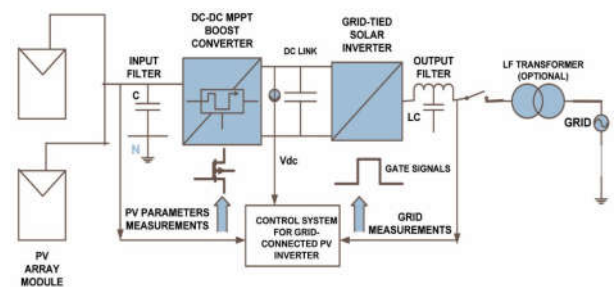

**Figure 3.5. Systemic Scheme of rooftop SPV at DTU Campus**

A solar photovoltaic module is a packaged interconnected assembly of solar units. The individual solar panel is a component of a larger P-V system to generate and supply electricity in residential and commercial applications because the power produced by a single solar panel is limited and small. This is called photovoltaic array. A photovoltaic power system comprises an array of solar panels, an inverter and interconnection wiring. Solar panels use light photons coming from the sun to generate electricity through the photovoltaic effect. The type of SPV Modules used will be of crystalline Silicon type with efficiency of about ≥16 %.



Technical specifications of the solar Module used are shown in following table:-

**Table 3.2: Technical specification of modules used for 432-KWp PV system**

Make of Solar Panel- Vikram Solar		
Serial No.	Characteristics	Details
1.	Peak Power $P_{max}$	300 Wp
2.	Maximum Voltage $V_{mp}$	37.28 V
3.	Maximum Current $I_{mp}$	8.05 A
4.	Open Circuit Voltage, $V_{oc}$	45.1 V
5.	Short Circuit Current, $I_{sc}$	8.74 A
6.	Efficiency	15.72 %
7.	$T_c$ for Open Circuit Voltage	0.052 %/°C
8.	NOCT	44°C +/- 2°C
9.	Junction Box	IP 65, 3 By Pass Diodes
10.	Dimensions	1979 X 991 X 38 (mm)
11.	Performance Warranty	90 % for 12 yr, 80% for 25 yr

### Mounting Structure

Number of P-V panels linked together in series and in parallel combination that give a direct current output for given incident solar irradiance. Tilt and orientation of panels are vital design parameters as well as shading due to surrounding obstructions.



**Figure-3.6. Mounting Structure of SPV**

Suitable number of Array frames will be provided. The array frames are made of MS Galvanized/ Aluminium and is protected against the corrosion and other environment impacts. The array frames would be certified for wind and seismic requirements of the area. The array frames are designed for simplicity, low cost and ease of installation at site. The galvanized steel structure provides support for the photovoltaic modules, has longer life, and gives them the optimum angle of inclination dependent on the system location. Technical specifications of the solar Mounting structure used are shown in following table: -

**Table 3.3: -Technical specifications for solar module mounting structure**

Sl No.	Attributes	Details
1.	Type	Fixed
2.	Tilt	25 °(acc. to location)
3.	Material	Galvanized Iron
4.	Tolerance	Hot Dipped Galvanizing
4.	Wind Speed Tolerance	≥ 150 Km/hr
5.	Hardware	All Hardware required for fixing structure and solar modules shall be provided
6.	Foundation	Not required

### Inverter

Solar photovoltaic is DC (Direct current) source. The DC output has to be converted to the grid alternating current (AC) by a power electronic device referred to as inverter/power conditioning unit.



**Figure 3.7. Inverter**

The synchronization happens automatically with available grid voltage & frequency and it starts to feed module output into grid. The other role of the solar power inverter is to operate the P-V system at its maximum power point (MPP) & extract maximum generation. The MPP is defined as the operating point where combined value of voltage & current result in maximum power output. This MPP fluctuates during operation in an interval depending upon the radiation, cell temperature & the cell type and it has to be tracked by the inverter controller unit. The Inverter for the 25 kW SPV power plant will be a grid connect which will be a combined unit comprising of inverter and necessary protections. Technical specifications of the solar inverter used are shown in following table:

**Table 3.4: - Technical specifications for solar grid connected Inverter used**

Sl No.	Attributes	Details
1.	Maximum DC Power	25550 W
2.	Maximum Input Voltage	1000 V
3.	MPP Voltage Range / Rated Input Voltage	390 – 800 V / 600 V
4.	Minimum Input Voltage/ Start Input Voltage	150 V / 188 V
5.	Maximum Input Current	33 A
6.	No. of Independent MPP Inputs	2
7.	Rated Power	25000 W
8.	Maximum AC Apparent Power	25000 VA
9.	Nominal AC Voltage Range	160-280 V
10.	AC Grid Frequency / Rated Grid Voltage	50 Hz / 230 V
11.	Maximum Output Current	36.2 A
12.	Maximum Efficiency	98.1 %

### Junction Box & Distribution Boards

A Junction Box is a passive device which takes the wires from several arrays and/or solar panels and combines them into one main bus or feed. Fuses (and fuse holders) or breakers can be included as per requirement. The Array Junction Box will be used to combine the strings from the PV array to one point to avoid complex cabling & losses. The junction box will comply IP 65 standard. The enclosure for the junction boxes and distribution boards will be dust and vermin proof. All necessary safety protections will be provided in the enclosure. All the circuit breakers, connectors etc will be as per standards. The output from each Combiner Box can be fed to a DC distribution board. DC distribution board is designed to isolate the solar module part from the inverter for maintenance

purpose. The AC Distribution Board is kept between inverter & grid. The purpose of AC DB is multifold. First, it protects the inverter from any surge coming from the grid & improves the MTBF (Mean time between failures). Secondly, it blocks the free flow of fault current and it is used to isolate inverter from the grid for maintenance. Technical specifications of the solar junction boxes and combiner boxes used are shown in following table: -

**Table 3.5: Technical specifications for Junction box and Distribution Board used**

Junction Box & Distribution Boards	
Type	Weather proof, Dust & Vermin proof
Cable Glands	Suitable Size
Terminals	Connector terminals for Copper cable and Bus Bar

**Cables, Earthing & Lightning Protection**

In order to have minimum losses in the solar photovoltaic power plant, cable selection is a critical activity of the design. The size of the cable is very carefully selected ensuring very limited power & voltage drop. The selection of cable is done considering the short circuit current that can flow through cables. The cables used are multi strand Copper cables. The cables exposed to environment are double sheathed –UV protected ones. All the cabling will be carried out as per the standards. Technical specifications of the solar cables used are shown in following table:

**Table 3.6. Technical specifications for Solar cables used**

Attributes	Details
Conductor	Multi stranded high conductivity Copper
Insulation/Sheath	PVC / XPLE Insulated
Cable lugs for termination	Provided in Installation kit
Temperature range	-10 °C- 70 °C
Certifications	650/1.1 KV grade as per IS 694 & IS 155

The earthing of all outdoor equipment & provision of associated earthing systems, electrodes & connections will be as per IS 3043 standards. Earth electrodes will be provided throughout plant areas along with the main earth grid. Adequate number of earth electrodes are provided so that the total earth grid resistance is less than 5 ohm & hence the possible fault current is taken care of. Earth electrodes will be made up of earthing rod of 17 mm diameter and 3 meters long. The earth electrodes will be provided in earth pits. The earth pit will be of two types – treated with earth links & untreated. The main buried grid conductors will be connected to all the earth electrodes to form a total earth grid. Galvanized steel flats will be used as per approved design. The frames of all electrical equipment & structural work will be earthed by connection to the earth grid by branches of same cross sectional area of earth grid. Lightning protection will be as per IS Standards. Vertical air termination of 40 mm diameter and 3-meter-long will be provided above highest point of array to ensure full radius protection to array.

**Modelling and Simulation of Photovoltaic Module using MATLAB Software**

**PHOTO-VOLTAIC CELL (P-V cell)**

The basic unit of a photovoltaic module is solar cell which has abilities to transform sun rays or photons directly into the electric power.

The solar cell being used is the P-N junction has slightly different electrical characteristics than a diode, and the same may be represented by the Shockley equation

$$I = I_s(e^{V_d/nV_t} - 1) \tag{1}$$

So, the procedure of modelling the solar cell is technologically advanced based on the gross current of the cell, the difference of the photo-current  $I_1$  or  $I_{ph}$ , i.e. the current produced due to photo-electric effect, directly proportional to the sun irradiation and normal diode current  $I_d$  as represented in equation below:

$$I = I_1 - I_d \tag{2}$$

So, hypothetically the perfect solar cell is modelled as a current source attached in antiparallel with a diode. The effects of series and shunt resistance decides the performance of solar cell. The model, which is designated as double-diode model, uses an equivalent circuit having two diodes that is quite complex due to the presence of a double exponential equation and six parameters to allocate. For simplifying another model based upon a single diode circuit, was used. In both the cases, there is a problem that the aforesaid mathematical models require the knowledge of six and five parameters respectively which are not openly available on manufactures datasheets. A beginner's single diode model, shown below in Figure 4.1, using just 04 parameters is widely accepted. However, in this model the voltage is not dependent on solar irradiance. Therefore, in current-voltage curves (I-V curves) a substantial voltage error is present particularly at open circuit and MPPT (maximum power point conditions). Lastly, a model having all parameters attainable from manufactures datasheet is planned. Numerical methods are required for the parameter determination of such model. The P-V model used, makes usage merely of parameters provided by manufacturer’s datasheets and no need of any numerical methods.

**CHARACTERISTICS OF PV CELL**

A perfect photo-cell is modelled by attaching a current source in parallel to single diode. Although, in practicality there is no perfect solar cell and hence shunt & series resistances are auxiliary to the model as shown below in P-V cell diagram. The value of series resistance ( $R_s$ ) is very small whereas the value of shunt resistance ( $R_p$ ) has a very high value.

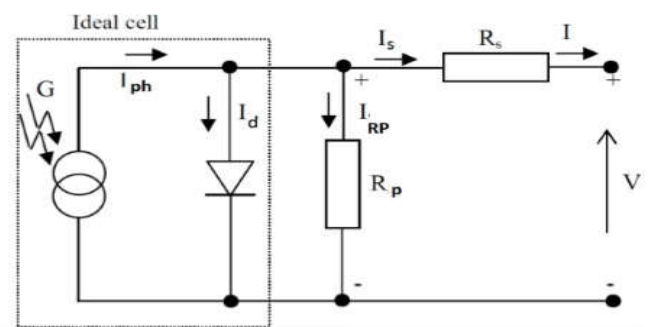

**Figure 4.1. Electrical Equivalent Model of a Photovoltaic Cell**

Applying Kirchoff’s law to the nodule where all  $I_{ph}$ , diode,  $R_p$  and  $R_s$  meet, we get

$$I_{ph} = I_d + I_{rp} + I \tag{3}$$

After reshuffling, the following equation for the photovoltaic current is obtained:

$$I = I_{ph} - I_{rp} - I_d \tag{4}$$

$$I = I_{ph} - I_0 \left[ \exp\left(\frac{V+IR_s}{V_T}\right) - 1 \right] - \frac{V+IR_s}{R_p} \tag{5}$$

Where,  $I_{ph}$  = Insulation current or photocurrent

$I$  = Current through cell

$I_0$  = Reverse saturation current

$V$  = Voltage through cell

$R_s$  = Resistance in series

$R_p$  = Resistance in parallel

$V_T$  = Thermal voltage

$K$  = Boltzman constant

$T$  = Temperature in Kelvin

$q$  = Charge of an electron

**EFFICIENCY OF P-V CELL**

The efficiency of a P-V cell is defined as the ratio of peak power to input solar power.

$$\eta = V_{mp}I_{mp}/IA \tag{6}$$

Where,  $V_{mp}$  = peak power voltage,

$I_{mp}$  = peak power current,

$I$  = solar intensity/m<sup>2</sup>

$A$  = solar exposed area (light incident area)

The condition of maximum P-V cell efficiency is that track the maximum power from the P-V system at different environmental conditions such as variable temperature and solar irradiance by using diverse approaches for maximum power point tracking (MPPT).

**P-V ARRAY MODELLING**

Solar cell is the basic building block of P-V arrays/modules., which itself is a p-n junction as like in diode that has capabilities of converting light energy to electrical energy. The equivalent circuit of same is represented below:

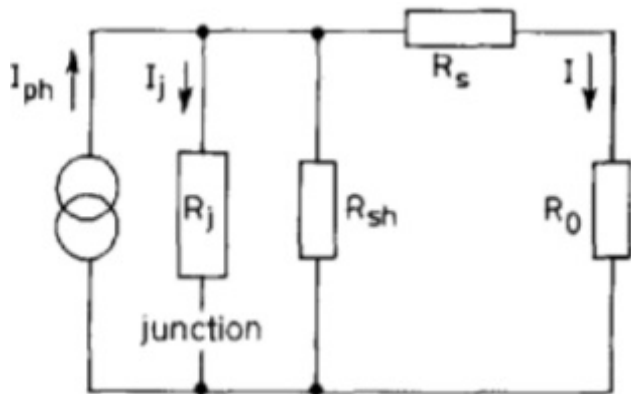

Figure 4.2. P-V Cell equivalent Circuit

$R_s$  represents the intrinsic series and shunt resistance of the cell respectively. Generally,  $R_{sh}$  value is very large and that of  $R_s$  is very small, therefore may be neglected for analysis simplification. Number of P-V cells are combined to form larger units called P-V modules, modules further inter-connected in series and parallel configuration to construct P-V arrays/generators. The mathematical model of simplified PV array is represented by the equation:

$$I = n_p I_{ph} - n_p I_{rs} \left[ \exp\left(\frac{qV}{KTAn_s}\right) - 1 \right] \tag{7}$$

Where,  $I$  = output current;

$V$  = output voltage;

$N_s$  = no. of cells in series and

$n_p$  = no. of cells connected in parallel;

$q$  = electron charge;

$k$  = Boltzmann's constant;

$A$  = Ideal factor of p-n junction;

$T$  = Cell surface temperature (K);

$I_{rs}$  = Reverse saturation current.

Ideal factor ( $A$ ) in above equation governs the deviation of solar cell characteristics from that of ideal p-n junction characteristics; its range is in between one to five but for our case, ideal factor is 2.46. The reverse saturation current ( $I_{rs}$ ) has variation with surface temperature as per the following equation:

$$I_{rs} = I_{rr} (T/T_r)^3 \exp\left[\left(\frac{qE_g}{KA}\right) (T_r^{-1} - T^{-1})\right] \tag{8}$$

Where,  $T_r$  = P-V cell reference temperature

$I_{rr}$  = P-V cell reverse saturation temperature at  $T_r$

$E_g$  = semiconductor band gap used in the cell.

The energy gap is also dependent on temperature of the semiconductor and is governed by:

$$E_G = E_G(0) - \left(\frac{\alpha T^2}{T} + \beta\right) \tag{9}$$

The photocurrent( $I_{ph}$ )is further dependent on the temperature of the cell and sun radiation as per the given equation:

$$I_{ph} = [I_{scr} + K_i(T - T_r)]s / 100 \tag{10}$$

Where,  $I_{scr}$  = Short-circuit current of P-V cell at the reference temperature

$K_i$  = SCC temperature coefficient

$S$  = incident solar radiation in mW/cm<sup>2</sup>.

The P-V power is determined by using equation (7) as follows:

$$P = VI = n_p I_{ph} V \left[ \left(\frac{qV}{KTAn_s}\right) - 1 \right] \tag{11}$$

**MATLAB CODE FOR P-V ARRAY**

```
close all;
clear all;
clc; T=302;
Tr1=40;
Tr=298; S=[100 80 60 40 20];
%S=70;
ki=0.00023;
Iscr=3.75;
Irr=0.000021;
k=1.38065*10^(-23);
q=1.6022*10^(-19);
A=2.15;
Eg0=1.166;
alpha=0.473;
beta=636;
```

```

Eg=Eg0-(alpha*T*T)/(T+beta)*q;
Np=4;
Ns=60;
V0=[0:1:300];
for i=1:5 Iph=(Iscr+ki*(T-Tr))*((S(i))/100);
Irs=Irr*((T/Tr)^3)*exp(q*Eg/(k*A)*((1/Tr)-(1/T)));
I0=Np*Iph-Np*Irs*(exp(q/(k*T*A)*V0./Ns)-1);
P0 = V0.*I0;
figure(1) plot(V0,I0);
axis([0 50 0 20]);
xlabel('Voltage');
ylabel('Current in SI unit');
hold on;
figure(2) plot(V0,P0);
axis([0 50 0 400]);
xlabel('Voltage');
ylabel('Power in SI unit');
hold on;
figure(3) plot(I0,P0);
axis([0 20 0 400]);
xlabel('Current in SI unit');
ylabel('Power in SI unit');
hold on;
end

```

As explained above, the P-V panel is influenced by temperature, light intensity, etc. The current-voltage (I-V) and power-voltage (P-V) characteristic curves drawn at different irradiance but at a constant temperature ( $25^{\circ}$  C) are shown below. The characteristic current-voltage (I-V) curve signifies that two regions are present in the curve: one side is the voltage source region at right side and other side it is current source region at left side of the curve. In the voltage source, the internal impedance is low whereas in the current source region, high impedance is there. Irradiance temperature is a vital factor that plays role in predicting the current-voltage (I-V) characteristic. The main difference is that the irradiance affects the output, whereas temperature mainly affects the terminal voltage. From PV characteristics, we can observe that, there exists a point where the power output is maximum for a particular condition of irradiance and load. If we are operating the PV panel at this point, operation of PV panel at this region gives the maximum efficiency.

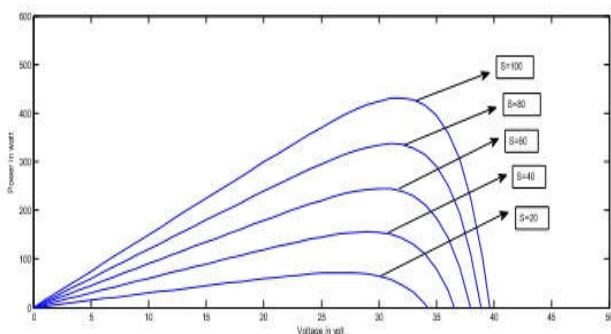

Figure 4.3: Power vs Voltage graph

This above model is derived by implementing several improvements such as function of temperature, function of the solar irradiance. Though, module electrical parameters which are open circuit voltage (OCV) and short circuit current (SCC), may be different from those provided by the manufacturer; Furthermore, these parameters may change with life of the module i.e.as the module is gets older parameters vary. Hence, mathematical model behaviour of a P-V module will never match with the real operating conditions.

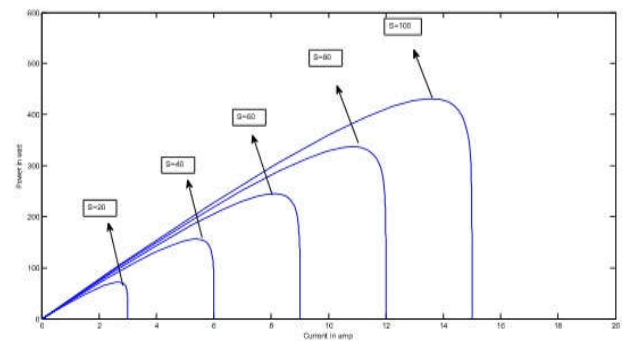

Figure 4.4. Power vs Current graph

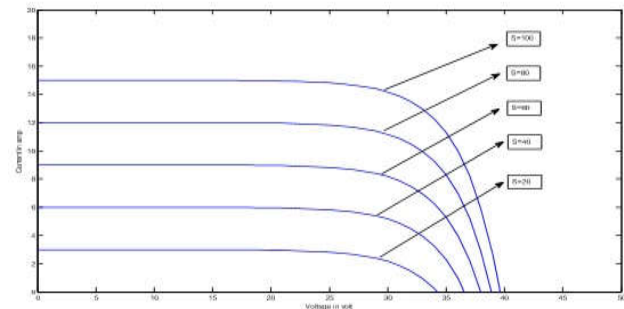

Figure 4.5. Current vs Voltage graph

### System Configuration for 432 KWp Grid-Connected Rooftop Solar Photovoltaic System

#### Therefore

- Total locations of SPV = 06
- Total Invertors = 17 (25 KW<sub>p</sub> each)
- Total SPV modules = 1440 (300 W<sub>p</sub> each)
- Total power output = 1440\*0.3 = 432 KW<sub>p</sub>

#### System Array Layout

**Site:** Delhi Technological University

Total Capacity: 432 KWp

Total Modules: 1440 Nos

Module Wattage: 300 Wp

Total invertors: 17 No.s

#### Comprehensive Details of Project

DTU campus has lush green campus spread over 160 Acres in Delhi 432 KWp. Solar photovoltaic grid connected power plant installed at DTU rooftops of various buildings like Mechanical engineering department, electrical engineering department and civil engineering department, etc. Major details of the project site are given in following table as follows: -

## RESULTS AND DISCUSSION

### ESTIMATION OF ANNUAL POWER GENERATION & ECONOMIC FEASIBILITY OF 432 KW<sub>p</sub> SPV SYSTEMS AT DTU

PV power plant works on GHI whose estimation is most important factor for estimating annual generation of power and plant financial feasibility. Ministry of New and Renewable Energy (MNRE) has set up solar radiation ground monitoring stations all across India for Measuring GHI, DNI and

5.1 For 90kW System (Buiding#1, Part-1) (Total-03 invertors& 300\*1 = 300 modules {300 W<sub>p</sub> each})



Figure 6.1- View of SPV installed at Building-1

Table 5.1:Specification of components used at Building-1, Part-1

Inverter No.	Inverter Rating	Module Rating( W <sub>p</sub> )	String Size	Voc/V mp(V)	Isc/Im p(Amp)	Total No. of String	Total No. of Module
Inv. – (1)	25 KWp	300 W <sub>p</sub>	20	902V/ 745.6V	8.6A/ 8.13A	5	100
Inv. – (2)						5	100
Inv. – (3)						5	100
Total						15	300

5.2 For 72kW System (Buiding#1 Part-2, Building#2 Part- 1&2, Building#3 Part-1) (Total- 4\*3=12 invertors& 240\*4 = 960 modules {300 W<sub>p</sub> each})



Figure 6.2:View of SPV installed at Building-2

Table 5.2:Buiding#1 Part-2, Building#2 Part- 1&2, Building#3 Part-1

Inverter No.	Inverter Rating	Module Rating( W <sub>p</sub> )	String Size	Voc/V mp(V)	Isc/Im p(Amp)	Total No. of String	Total No. of Module
Inv. – (1)	25 KWp	300 W <sub>p</sub>	20	902V/ 745.6V	8.6A/ 8.13A	4	80
Inv. – (2)						4	80
Inv. – (3)						4	80
Total						12	240

### 5.3 For 54kW System (Building#3, Part-2) (Total- 02 invertors& 180\*1 = 960 modules {300 W<sub>p</sub> each})



Figure 6.3: View of SPV installed at Building-3

Table 5.3: Specification of components used at Building-3, Part-2

Inverter No.	Inverter Rating	Module Rating( Wp)	String Size	Voc/V mp(V)	Isc/Im p(Amp)	Total No. of String	Total No. of Module
Inv. – (1)	25 KWp	300 Wp	20	902V/	8.6A/ 8.13A	5	100
Inv. – (2)				745.6V		4	80
Total						9	180

Table 5.4: Technical details of Solar Photovoltaic Modules

S. No.	Location	Module	Module Wattage (Wp)	Capacity (KWp)
1.	Building-1	Part-1	300	90
		Part-2	240	72
2.	Building-2	Part-1	240	72
		Part-2	240	72
3.	Building-3	Part-1	240	72
		Part-2	180	54
Total Power:				432 KW

Table 5.5: Major details of project

Serial No.	Parameters	Details
Summary of 432 KWp Solar PV Plant		
1.	Location	DTU, Delhi (28.45°N, 77.07 ° E)
2.	Elevation	216 m
3.	Location of SPV system	Roofs of the departments
4.	Capacity of SPV system	432 KWP
5.	Roof Type	Flat
6.	Topology used	Grid connected
7.	Photovoltaic module type	Crystalline
8.	No. of cells in a module	72 cells
9.	Tilt angle	25°
10.	No. of PV modules	1440
	No. of invertors	17
11.	Invertor output	415 VAC , 3 PHASE
12.	Estimated annual generation (kWh/m <sup>2</sup> /day)	5.4
13.	Estimated annual generation (estimated in next chapter)	635677 units (KWh)

**Table 6.1: Annual solar resource assessment**

Month	Average Monthly GhI (kWh/m <sup>2</sup> /day)
JANUARY	3.45
FEBRUARY	4.76
MARCH	6.09
APRIL	6.83
MAY	7.03
JUNE	6.34
JULY	5.57
AUGUST	5.41
SEPTEMBER	5.44
OCTOBER	5.04
NOVEMBER	3.99
DECEMBER	3.30
ANNUAL AVERAGE	5.27

**Table 6.2. Annual estimated power generation data**

MONTH	Estimated Power Generation (KWh)
JAN, 2016	42803
FEB, 2016	49458
MAR, 2016	63651
APR, 2016	64476
MAY, 2016	59839
JUN, 2016	52764
JUL, 2016	47698
AUG, 2016	50851
SEPT, 2016	54418
OCT, 2016	58009
NOV, 2016	48102
DEC, 2016	43728
ANNUAL AVERAGE	635677
Estimated Cost saving per year	
Cost per unit (SPV)	Rs 5.80/KWh
Cost per unit (NDPL/TDTPL)	Rs 9.00/KWh
Estimated DTU Cost saving per year	635677 KWh * (Rs 9.00 – Rs 5.80) = Rs 2,034,166

equivalent sunshine hours for particular site. Average Global Horizontal Irradiation (GHI) for Delhi region comes out to be in range of 3.3 KWh/m<sup>2</sup>/day to 7 KWh/m<sup>2</sup>/day. Monthly average irradiation on ground for the site is given in following table: - With annual average GHI values of 5.27 KWh/m<sup>2</sup>/day and assuming 310 clear sunny days for Delhi region, monthly generation potential for 432 KW system is estimated by multiplying system capacity with average daily GHI values and number of clear sunny days in a year which comes out to be 635677 KWh annually or 1470 KWh annually per kW of solar PV system installed at Delhi. Monthly power generation potential calculated month wise is shown in following table: - However, the operation of 432 KWp solar rooftop power plant came in operations from 01<sup>st</sup> March 2017. The first bill submitted by the M/s Hero Future Energies Limited is for the period of 01st March, 2017 to 31st March, 2017 and given below:

- Electronic Block (Meter No.- XB456441) – 8,559 KWh
- Electronic Block (Meter No.- XB456439) – 2,671 KWh
- Electronic Block (Meter No.- XB456404) – 5,052 KWh
- Science Block (Meter No.- XB456434) – 13,878 KWh
- Mechanical Block (Meter No.- XB456414) – 8,878 KWh
- Mechanical Block (Meter No.- XB456435) – 12,100 KWh

**Therefore,**

- Total power generated rooftop SPV system = 8,559 +2,671+5,052+13,878+8,878+12,100 KWh = 51,148 KWh in March, 2017.

- Charge per unit of power =Rs 5.80/KWh
- Amount payable by DTU = Rs 5.80/KWh \* 51,148 KWh = Rs 2,96,658

**If same power is purchased from NDPL/TPTDL then,**

- Charge per unit of power =Rs 9.00/KWh
- Amount payable by DTU = Rs 9.00/KWh \* 51,148 KWh = Rs 4,60,332

**Hence,**

Net saving in one month = Rs 4,60,332 – Rs 2,96,658 = **Rs 1,63,774**

**Assuming,**

- Uniform power generation
- Constant efficiency
- Uniform radiation throughout the year
- Constant losses in the system

Then, net cost saving in one year by DTU = Rs 1,63,774/Month \* 12 Months

= **Rs 19,65,288/year** which is close to our estimated cost saving i.e. **Rs 2,034,166**

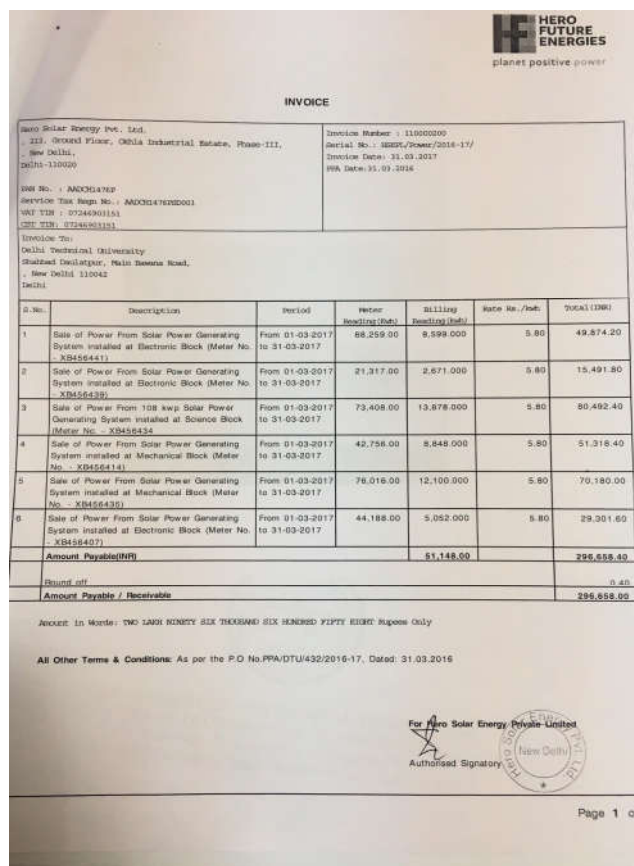

**Figure 6.1: Bill of payment from 01/03/2017 to 31/03/2017**

**RESULTS**

After estimating the generation potential for PV power plant, financial feasibility is done by calculating payback period for the system which should be low as possible. PV Modules used are of Vikram or Renesola make of multi crystalline based silicon technology, Inverters used are of SMA, Delta or Sukam

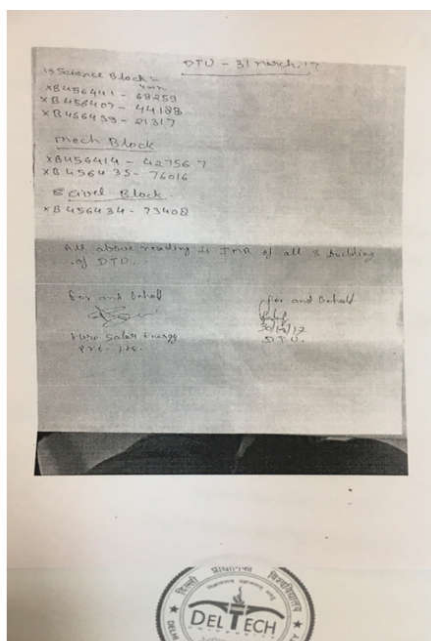

**Figure 6.2: Meter readings for the period from 01/03/2017 to 31/03/2017**

**Table 6.3: - Economic Feasibility OF 432 KWp Power plant**

Component	Quantity required	Total cost
Module cost @ Rs 34/watt p	1440 modules of 300 Wp each	Rs 14688000/-
Inverter cost @ Rs 10/watt	17 inverters of 25 KVA rating each	Rs4250000/-
GI Structure and civil work @ Rs 110/kg	1 complete set for 432 kW PV array mounting with 70 KG GI required for 1 KW array mounting	Rs3326400/-
Electrical interconnection with grid @ Rs 3/watt	Array interconnection, connection to inverter and to LT panel/grid	Rs 1296000/-
Miscellaneous	Other BOS, Transportation, taxes etc	Rs1178020/-
Total cost for 432 KW system	Sum of all above costs	Rs24738420/-
MNRE subsidy availed @ 30 % of project cost under institution scheme	Subsidy applicable for College institutions/universities	Rs7421526/-
Net cost incurred by M/s Hero future Energies Limited.	Total cost for project minus subsidy availed	Rs17316894/-
Annual Units generated by SPV @ 5.80 Kwh/m <sup>2</sup> /day ( for 300 working days)	Based upon the theoretical estimation of solar radiation throughout the year. (Estimated above in previous chapter Table 6.2)	635677KWh
Cost recovered by M/s Hero Future Energies Limited from rooftop SPV @ 5.80 Kwh/m <sup>2</sup> /day (for 300 working days) per year	Based upon the theoretical estimation of solar radiation throughout the year. (635677 KWh * Rs 5.80/KWh)	Rs3,686,926/-
Payback period for M/s Hero Future Energies Limited.	Rs 1,73,16,894/ Rs 36,86,926	4.69 years
Estimated Annual cost saving benefits for DTU@ Rs9.00/unit charged by Local Discom	Electricity charges high due to college lying under commercial consumer category 635677 KWh * (Rs 9.00 – Rs 5.80)/KWh	Rs 2,034,166/-

with data loggers, mounting structure used are of corrosion resistant hot dip galvanized iron and other balance of systems are of reputed make.

Basis of estimation of annual benefits is calculated on electricity process paid by the DTU per KWh consumed. Following table shows the economic analysis of the 432 KW power plant by showing cosy incurred due to various components of plant: -

### Future Recommendations

After analysing the Solar Rooftop photovoltaic system of capacity 432 KW power, it has been found that the rooftop SPV systems can be further improved by optimising the position and tilt of the panels in order to avoid the shadow effect of individual panels when arranged in an array. This analysis can be done by different software available for shadow analysis like the one Google Sketch 3 D used above to analyse the shadow effect by considering different angle of tilt and varying positions of the panels. Further, we can use simulation software to simulate the performance of SPV system to get the maximum power point for which usually Maximum Power Point Tracking Technique (MPPT) is used like the one MATLAB software used above to perform the same task. In addition to this cost reducing manufacturing techniques are also needs to to researched so as to make the solar panels more affordable and assessable and policies are to made in this regard to encourage the use solar rooftop panels to use the unused space for power generation. All the above efforts will serve dual advantage to the country one is cost saving and other is sustainable use of fossil fuels.

### Conclusion

Thus, roof top PV systems have a high potential in form of annual power generation and low payback periods under 3 years for the states like Delhi, which are blessed with enormous sunshine availability throughout the year. Also current electricity prices are very high in Delhi for consumer, which is not in residential category that also makes installing solar rooftop project financially viable in Delhi. Also, land availability in Delhi in big problem, which makes the rooftop concept a great idea to make Delhi power sufficient state. In addition, DTU will help in reducing Global warming by offsetting greenhouse gas emissions (GHGs). Hence, DTU administration will be highly benefitted by installing solar rooftop plant by making its contribution to complete 100 GW solar power targets set by Government of India by 2022.

### Acknowledgement

While carrying out this research work to its final form, I came across a number of qualified and professional people whose contributions in different ways helped my field of research work and they deserve special thanks. It is a pleasure for me to convey my gratitude to all of them. Primarily, I would like to express my deep sense of gratitude and obligation to my guide Dr. J.P. Kesari and co-guide Prof. R.S. Mishra for their invaluable encouragement, suggestions and support from an early stage of this research work and providing me several extraordinary knowledge and experiences throughout the work. Above all, their invaluable and scrupulous supervision at each and every phase/stage of this research work inspired me in countless ways. I specially acknowledge them for their advice, guidance, supervision, and the vital contribution as and when required during this research. His involvement with originality has activated and nurtured my intellectual maturity that will help me for a long time to come in my life.



I am proud and pleased to record that I had the opportunity to work with exceptionally experienced Professors like them. I am highly grateful to Prof. R.S. Mishra, Head, Department of Mechanical Engineering Department for their kind support and permission to use the facilities available in the Institute. The support and cooperation received is difficult to express in words. The time spent with them will remain in my memory for years to come. Finally, I am extremely indebted to my mother, Mrs. Rakesh Kumari, my father, Mr. Devendra Kumar, for their moral support and continuous encouragement while carrying out this study.

## REFERNCES

- Zhang, L., Jing, D., Zhao, L., Wei, J. and Guo, L. 2012. "Concentrating PV/T hybrid system for simultaneous electricity and usable heat generation: a review," *International Journal of Photoenergy*, vol., Article ID 869753, 8 pages, 2012
- Sampaio, Priscila Gonçalves Vasconcelos, and Mario Orestes Aguirre González. "Photovoltaic solar energy: Conceptual framework." *Renewable and Sustainable Energy Reviews* 74 (2017): 590-601. 3. Bellia, H., Youcef, R., & Fatima, M. (2014). A detailed modeling of photovoltaic module using MATLAB. *NRIAG Journal of Astronomy and Geophysics*, 3(1), 53-61.
- Praveen, J., Vijaya Ramaraju, V. 2017. Materials for Optimizing Efficiencies of Solar Photovoltaic Panels, *Materials Today: Proceedings*, Volume 4, Issue 4, 2017, Pages 5233-5238, ISSN 2214-7853, <http://dx.doi.org/10.1016/j.matpr.05.032>.
- Lingkun Liu, Yuting Jia, Yaxue Lin, Guruprasad Alva, Guiyin Fang, Performance evaluation of a novel solar photovoltaic-thermal collector with dual channel using microencapsulated phase change slurry as cooling fluid, *Energy Conversion and Management*, Volume 145, 2017, Pages 30-40, ISSN 0196-8904,
- Nouran M. Ali, Nadia H. Rafat, Modeling and simulation of nanorods photovoltaic solar cells: A review, *Renewable and Sustainable Energy Reviews*, Volume 68, 2017, Pages 212-220, ISSN 1364-0321, <http://dx.doi.org/10.1016/j.rser.2016.09.114>.
- Executive engineer office, administrative building, DTU.
- Vikram Solar photovoltaic modules company, [www.Vikramsolar.com](http://www.Vikramsolar.com)
- SMA grid connected Inverter Company, [www.Sma-india.com](http://www.Sma-india.com)
- Ministry of New and Renewable Energy (MNRE) National Institute of solar Energy, Gurgaon website *Renewable Energy in India: Growth and Targets* Ministry of New and Renewable Energy (MNRE) report.

\*\*\*\*\*